

# Design Guide

Laminam 12+  
1620x3240x12mm

02	Intro
04	1 / The Product
06	2 / Laminam Examples
11	3 / The Range
13	4 / Quality Control
15	5 / Design
20	6 / Edges
23	7 / Transport and Installation of the Finished Top
25	8 / Cleaning and Maintenance
29	9 / Surface Restoring
30	10 / Technical Specifications
32	11 / Warranty

## Intro

Laminam 1620x3240x12mm

The Laminam pure ceramic slabs in the 1620x3240mm size, 12mm thick. They offer priceless millimetres of extra space for the hands of skilled workers, providing them with more creative freedom than ever before.

These surfaces are designed **for the world of furnishings, from horizontal surfaces to large, top-of-the-range kitchens and bathrooms.**

Thanks to their excellent technical performance, Laminam slabs are ideal for the most delicate of uses, requiring maximum hygiene and resistance. The aesthetic virtues of the large size offer a major artistic advantage, guaranteeing material continuity throughout the settings, in sophisticated, natural shades.



**Tabletop**

I Naturali Noir Desir  
Laminam 12+  
1620x3240mm

# 1 / The product

## The special features of Laminam 12+

Ideal material for creating horizontal surfaces: kitchen worktops, bathroom countertops, table tops. 12mm thick, full-body porcelain stoneware surface in the 1620x3240mm size.

Fibre reinforcement applied to the back during an automated industrial process.

## Laminam 12+

Laminam 12+ is made up of a base slab, strengthened with a fiberglass blanket bonded on the back.

Processing surface: 1620x3240mm

Nominal thickness: 12mm

## Use of Laminam 12+

- > Furnishing and interior design sector: flat surfaces for bathrooms and kitchens, splashbacks, tables, desks and furnishings in general.
- > Shipbuilding sector: finishing material.
- > Building sector\*\*\*: wall covering systems.

## Technical specifications Laminam 12+

Laminate porcelain obtained by wet grinding of clay raw materials, granite and metamorphic rocks, with a feldspathic component and ceramic pigments. Specially shaped in a compactor and sintered at 1200°C, with gas firing. Structurally reinforced with inert material (fiberglass blanket bonded on the back).

**Hygienic surface suitable for contact with foodstuffs.** Laboratory tests have proven that Laminam is totally compatible with foodstuffs, as it does not release elements in solution.

**Easy to clean and maintain.** Laminam 12+ is simple, fast and easy to clean. Laminam 12+ has no special maintenance requirements as time goes by; generally speaking, all you need to clean the surface is warm water and a neutral detergent.

**Compact surface, no surface porosity (water absorption 0.1% average value).** The water absorption of Laminam is average 0.1%.

**Dimensional stability.** Laminam 12+ is not subject to dimensional variations of any significance, as it has a low coefficient of thermal expansion.

**Suitable as an indoor or outdoor solution.** Laminam can be used as a surface for interior or exterior décor.

**Resistant to heat and high temperatures.** The ceramic surface does not contain any organic materials and so its surface is not altered in case of direct contact with very hot items in the kitchen, like pots and pans, and high temperatures.

**Resistant to mould and fungi.** Laminam does not allow mould, bacteria or fungi to grow.

**Resistance to staining.** Laminam 12+ is not affected by prolonged contact with products commonly found in the kitchen that can cause staining, such as wine, coffee, olive oil, or lemon juice, and its colour or shine will not be affected permanently.

**Resistant to detergents and cleaning products.** Laminam 12+ is not affected by prolonged contact with normal household detergents, including products to eliminate grease or lime scale.

**Resistant to chemicals, acids, alkalis and solvents.** Laminam 12+ is not affected by chemicals, solvents or disinfectants. The only chemical that can damage ceramics is *hydrofluoric acid*.

**Resistant to thermal shock.** Sudden changes in temperature out of doors will not damage Laminam 12+.

**Frost resistant.** The ceramic surface of Laminam 12+ is not affected by drops in temperature or the formation of ice.

**Resistance to humidity.** The ceramic surface of Laminam 12+ is not affected by long-term humidity.

**Resistant to UV light, no alteration to colours.** Laminam 12+ is not affected by exposure to UV light and will preserve its original good looks throughout its lifetime.

**Resistant to flexion.** Laminam 12+ has a high modulus of rupture.

**Resistant to scratching and abrasion\*\*.** Laminam 12+ is resistant to scratching and deep abrasion. Its properties do not change even if it is subjected to intensive use in the kitchen and frequent cleaning.



## 2 / Laminam Examples



### Tabletop

I Naturali Noir Desir  
Laminam 12+  
1620x3240mm





**Benchtop and fronts**

Ossido Nero  
Laminam 12+  
1620x3240mm



**Outdoor tabletop**

Collection Bianco  
Assoluto  
Laminam 12+  
1620x3240mm

**Tabletop**

I Naturali Noir Desir  
Laminam 12+  
1620x3240mm





**Tabletop**

I Naturali Ardesia Nero a Spacco  
Laminam 12+  
1620x3240mm



### 3 / The Range

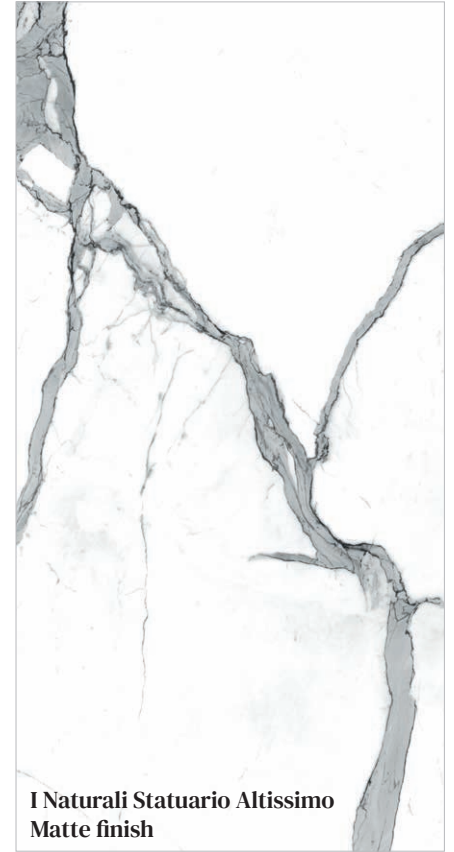
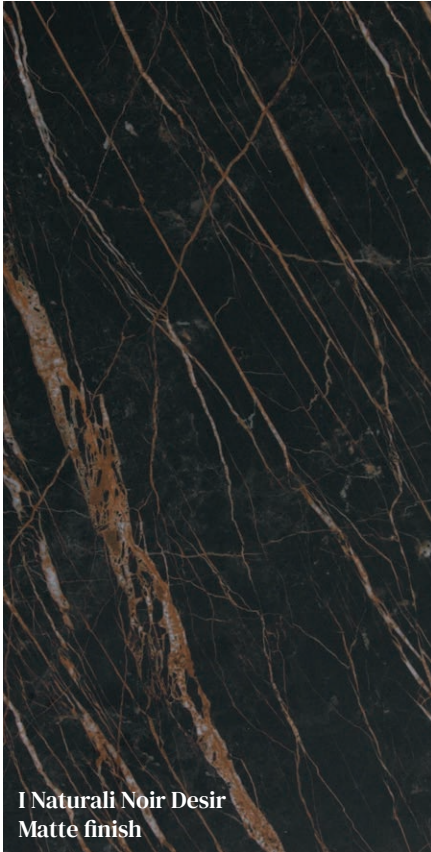

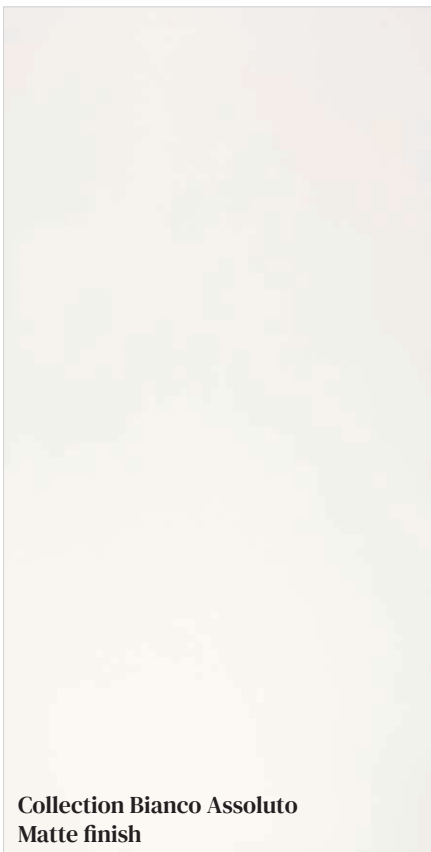

## 4 / Quality Control

### 4.1 Size

The term 'Full Size' indicates the slab that has completed its unground production cycle. This size is intended for processing, as the manufacturer has the opportunity to optimise the possible cutting patterns according to the project at his own discretion.

From each slab you can obtain a size of 1620x3240 mm, corresponding to the useful and invoicing surface.

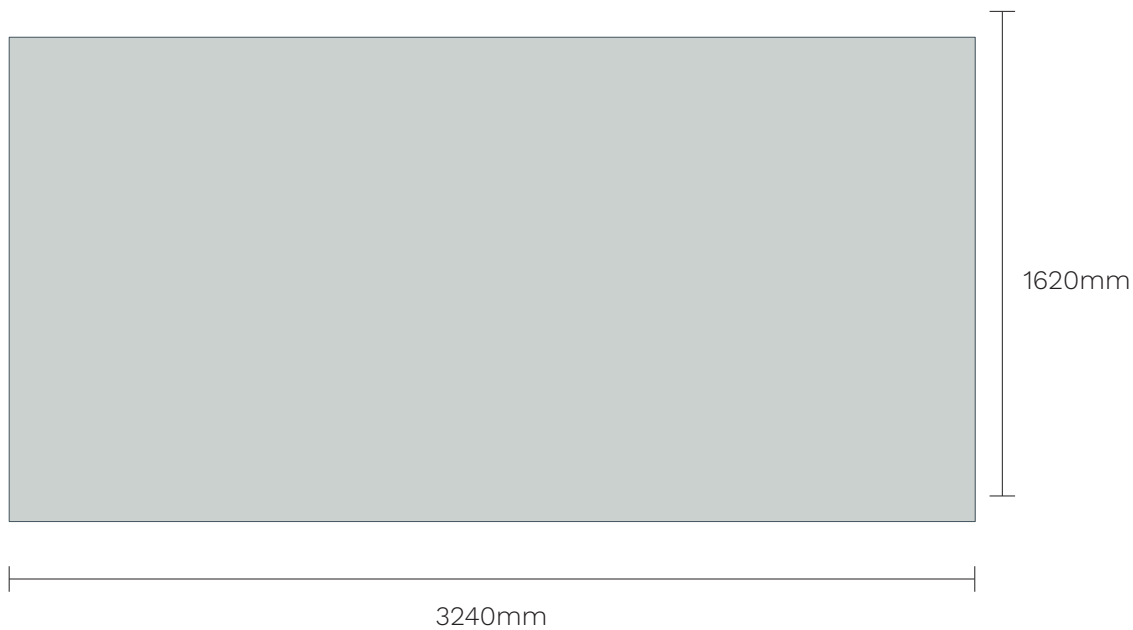



## 4.2 Shade

Laminam 12+ slabs are produced from natural raw materials and manufactured using an industrial process. Although they are not subject to major aesthetic variations, as is the case with natural stones, they can be subject to normal, minimal colour variations.

Laminam S.p.A's production process includes a careful selection phase to divide and mark the different shades, ensuring that the product always falls within the quality thresholds that the Company has set itself.

These variations are to be considered a natural characteristic of Laminam slabs.

Slabs with the same finish but different size and thickness will always have different shades, but they will still fall within the range set by the company.

When manufacturing products, we suggest avoiding the combination of slabs of the same finish in different thicknesses and shades on the same plane.

There may be more than one shade of the same finish in a single package, as marked on the label on each slab. It is therefore necessary to check the uniformity of the shade for projects that involve the use of more than one slab.

Each shade cannot be repeated; if the finish is still in production, on request Laminam S.p.A. can search for and supply the material available in the warehouse that has the shade closest to that of the slabs previously purchased.

## 4.3 Surface Quality

Laminam slabs are obtained through the use of only natural raw materials, fired at high temperatures (> 1200°C). Such conditions may give rise to the formation of irregularities.

Laminam S.p.A classifies Laminam 12+ slabs into three distinct surface quality categories: Q1, first choice, Q2, second choice, QT, technical support.

According to the ceramic standards of the sector, the aesthetic conformity of the surface of Laminam materials must be carried out visually by placing the slabs in a horizontal position, under natural or artificial light, placed perpendicular to the surface to be observed (no backlit) and at a distance of not less than 1 m.

The presence of these irregularities on the first choice (Q1), although controlled within parameters of selection, is a characteristic of the naturalness of the material.

## 5 / Design

### 5.1 Minimum distances from the edges

In the design of a kitchen top, maintain a minimum distance of 50 mm from the outer edge with holes and grooves. The same minimum distance must be maintained between adjacent openings. The minimum distance between a cutout and the edge of the slab must be at least 30mm.

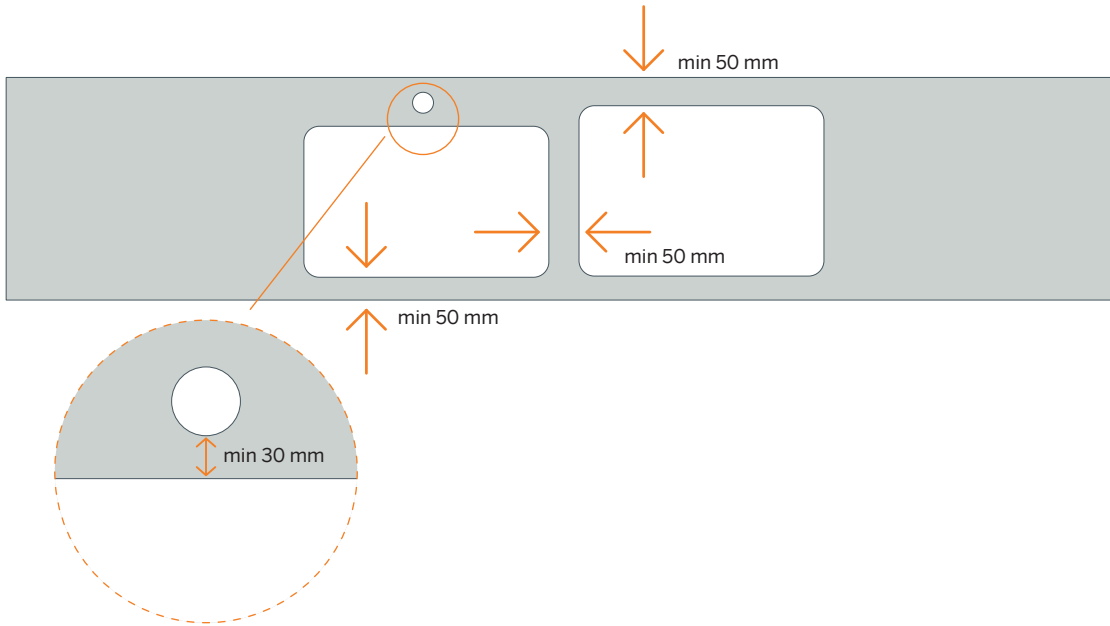

### 5.2 Inside corners

To create internal corners and openings, create a joint of at least 5 mm in the angle to distribute the stresses, as is generally done when working stone, marble and bonded materials.

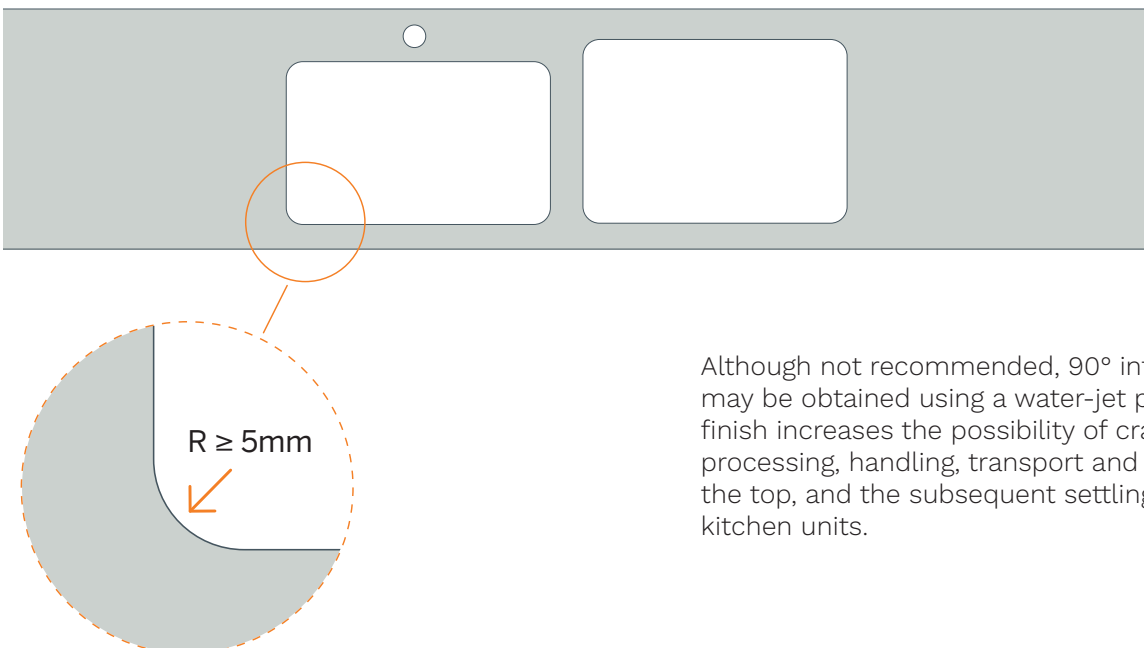

Although not recommended, 90° internal angles may be obtained using a water-jet process. This finish increases the possibility of cracking during processing, handling, transport and installation of the top, and the subsequent settling of the various kitchen units.

### 5.3 Installation of sinks and hobs

Laminam 12+ can be processed to obtain a range of configurations for sinks and hobs.



- **Top-standing installation:**

Corresponding to flush-mounting of the most conventional and simple kind of processing, with a protruding edge of a few millimetres, above the work top.

- **Top-flush installation:**

Top flush installation leaves no overlapping edges and the hob is fitted into a groove a couple of millimetres deep made in the top, depending on the thickness of the edge of the sink or hob to be fitted into the kitchen top. It is a more practical solution for cleaning but is trickier to fit.

A minimum gap of 1mm between the edge of sink or hob and rebate. This can be filled with a suitable silicone filler/adhesive.

Removing more than 6mm from the surface is not recommended.

- **Under-top installation:**

Used for sinks, this solution ensures the uniformity of the work top surface as it has no edges. Cleaning and hygiene are also quicker and simpler as there are no protrusions to capture dust and dirt.

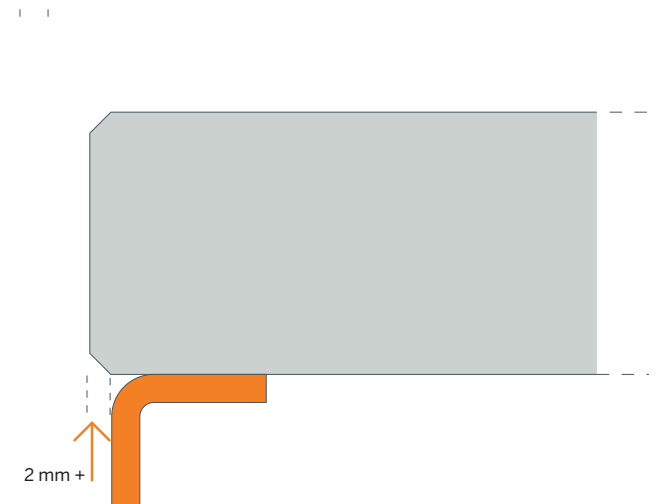



## 5.4 Installation of sinks and hobs

Laminam 12+ slabs must be processed to obtain openings having scrupulously checked the processing measurements given in the technical sheet of the specific product to be installed, depending on the chosen installation method.

Leave a minimum distance of 1 mm between the sink or hob and the Laminam top, to allow for thermal expansion.

When fitting a prefabricated sink below the top, chamfer the edge of the Laminam 12+ slab around the hole. When fitting the prefabricated sink and/or hob seal the edges with silicone, adhesive seal or an equivalent product.

A Laminam fabricated sink is possible. Consultation with the fabricator is required on a case by case basis. Not all fabricators would attempt to incorporate.

Use one or two support bars to support large heavier sinks, fixed to the unit frame, in order to avoid stresses to the countertop.

## 5.5 Wall joint

Install the top at a distance of 2-3 mm from the wall.

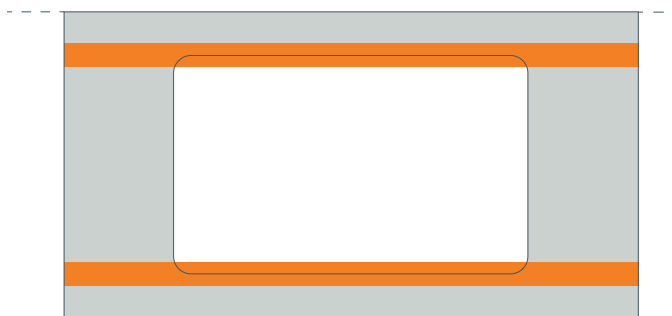
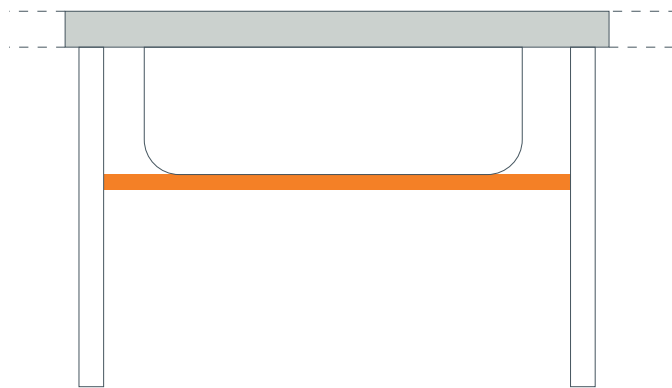

## 5.6 “L” top and joint

When creating “L” shaped tops, it is advisable to fit the slabs using a straight pattern. When installing the top, fill the joint between the two slabs with silicone.

A diagonal joint is advised for directional pattern.

In case of finishes that have a non-uniform and / or with a direction pattern, perform a preliminary check on the parts to be joined to make them compatible as much as possible.

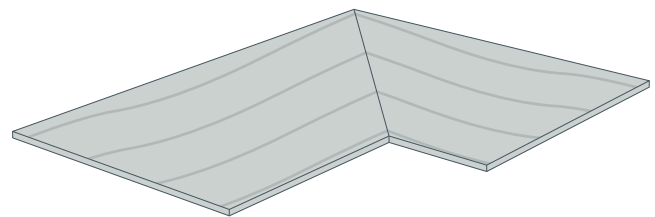
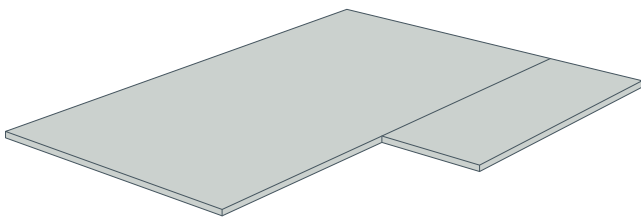
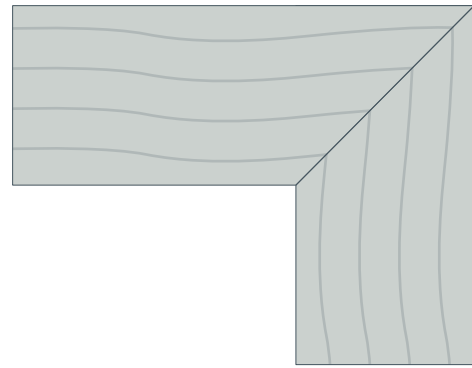

### 5.7 Reinforcements and Fixings

In order to give more strength to the top, it is important to observe the following guidelines:

- in the case of countertops with edges made of 12mm thick (without front edge), supports are to be guaranteed in correspondence on the whole perimeter of the cabinets and across each cabinet of the kitchen, with particular attention to areas next to sinks and hobs.
- countertops made directly with front edge and miter cut may be reinforced by the insertion of bars

(for example in Laminam 12+, aluminum or other types of panel) taking care to use sufficiently elastic adhesives.

#### Tables

To fix the Laminam 12+ slab to the tables frame it is possible to use glass accessories, such as recessing anchoring, with an indicative maximum depth of 6mm.

Alternatively, depending on the table frame and the use, e.g. indoor or outdoor, it is also possible to use Velcro or adhesives.

### 5.8 Overhangs and table extensions

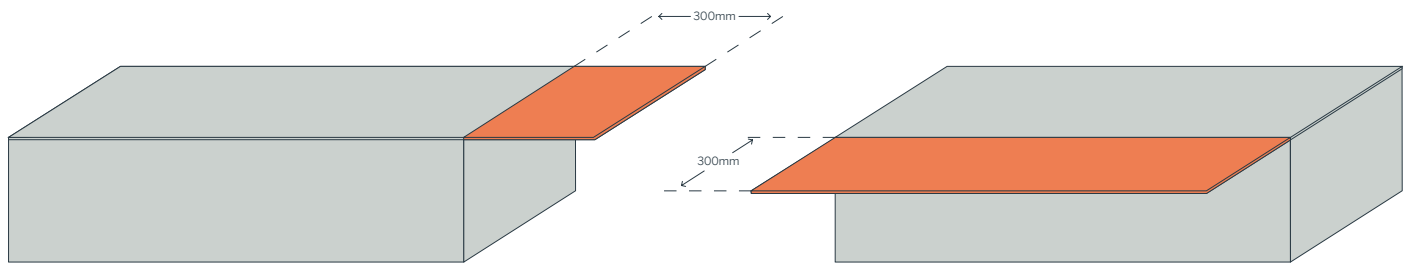

300mm unsupported overhang. Fiberglass backing may be removed 100mm back from the exposed edge of the horizontal surface. Remove as necessary on vertical edges e.g. waterfall ends.

**Note: The exposed pattern on the back of the vertical leg will not match the face.**

The production of overhangs using Laminam 12+ slabs has been tested to standard EN 1730:2012 "Furniture. Tables. Test methods for the determination of stability, strength and durability".

In a configuration of a 800 mm table top

Top width	Maximum span	Maximum deflection	Tests passed
800mm	350mm	6.5mm	<ul style="list-style-type: none"> <li>• Load applied 50mm from the edge: 1000 N</li> <li>• Stress: 10000 cycles, applied load 300 N</li> <li>• Impact: 10 knocks, 25 kg weight, falling height 180mm</li> </ul>

Any larger spans shall be tested by the producer.

If the table has extensions, use the same Laminam 12+ slab for both the table top and the extensions. This procedure ensures a uniform colour and thickness of the finished table. This also allows to create continuity in terms of flatness between top and extensions, in case of small deviations of the slab covered by the tolerance. If extensions are made from different plates, verify tone, graphics and flatness matching.

It is also advisable to obtain the extensions and top continuously from the same slab, above all if the finish has a preferential direction.

## 6 / Edges



The edge can be finished using automatic machinery (e.g. edge polisher, numeric control) or by hand, depending on the visual effect desired.

### 6.1 Straight edge and chamfering

The straight edge is the finish that keeps the edge of the Laminam 12+ slab visible. It can be used as a perimeter edge for table tops and kitchen tops, or to finish the sink hole when the sink is fitted beneath the top.

Subsequently, where required, it is possible to polish the edge using a sequence of abrasive diamond grinders, with increasing grit size, on numeric control machines.

Laminex NZ recommend a minimum 2 mm radius or 2mm bevel with edge radius of .5mm to increase impact resistance. The greater the radius, the better it will bear any impacts.

Treat the edge like glass. Due to the hardness of the surface, it increases the brittleness of the edges. Impact with a hard, heavy object could result in chipping of the edge. Accidental damage is not covered under warranty.

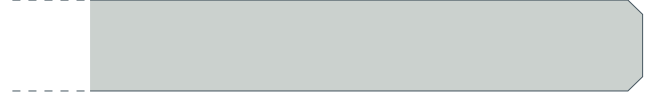

Remember that the greater the bevel, the more base colour in the slab will be visible.

Generally only the upper corner must be chamfered, but in some cases it may be necessary to chamfer on both sides: in this case, use equipment that can perform the operation in a single passage.

For chamfering curved cuts, use a CNC machine with a 5-axis grinder.

The final passages of polishing and chamfering may be completed by hand, using special diamond pads fitted on a grinder: in this case the precision of the result is linked to the skill of the operator.



### 6.2 Other types of edges

Other types of edges (such as bullnose and half bullnose) can be obtained using special profiling grinders fitted on numeric control machines.

Many edge finishes can therefore be obtained using different grinders.

The operating speed must be checked in advance.

Recommended radius/bevel or combination of.

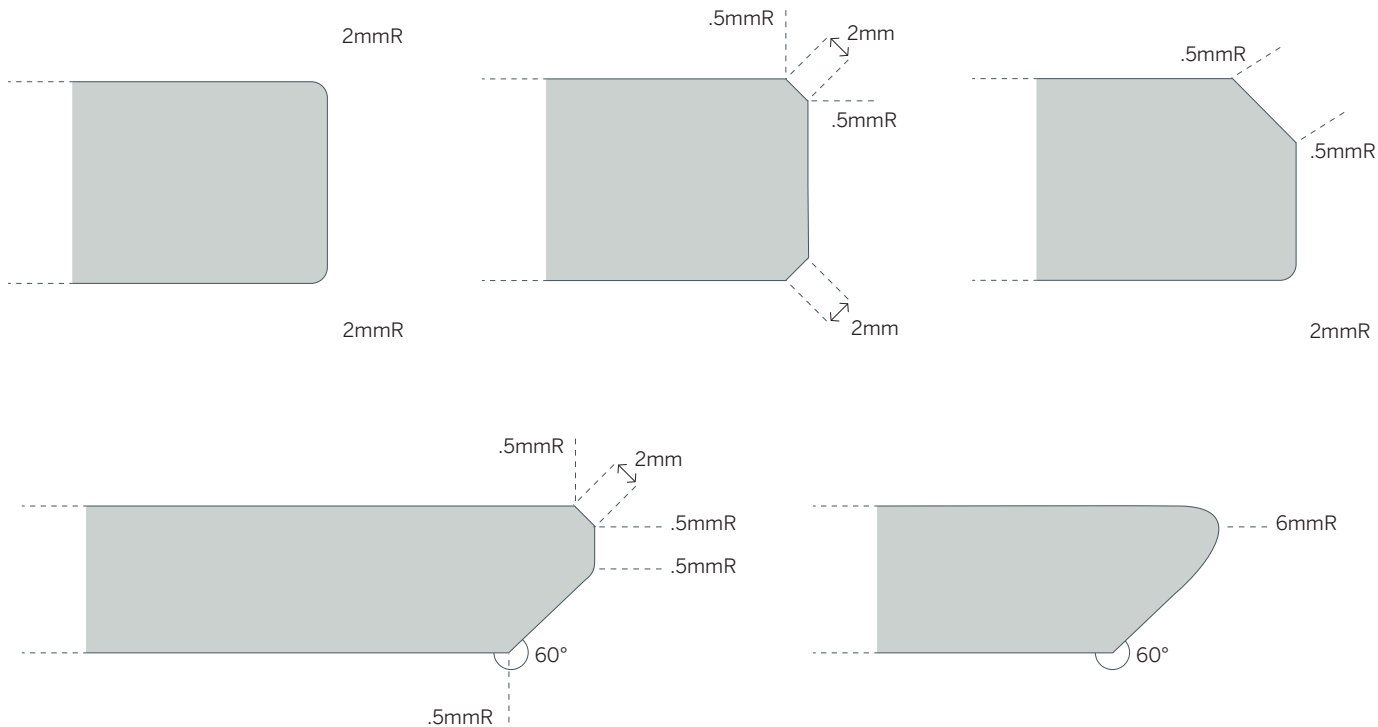

### 6.3 45° edges

Laminam 12+ can be machined to create continuous joints for a build up of a greater height than the thickness of the product, sinks and recesses.

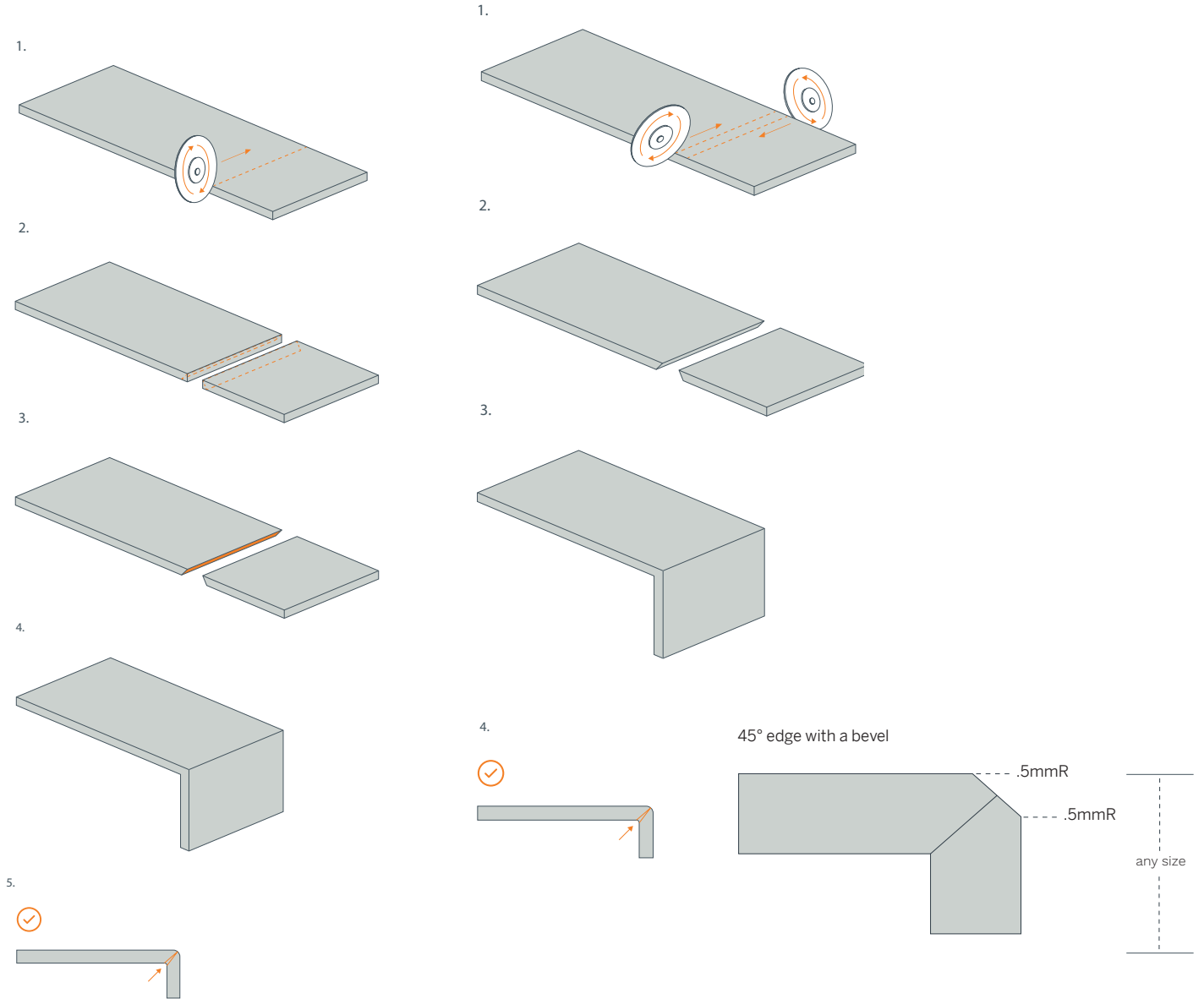

### 6.4 Fibre sanding

To improve the appearance of visible edges, the reinforcing fibre can be removed along the perimeter of the slab by hand using a grinder with diamond pad.

This should be done for a maximum width of 100mm from the outer edge.

## 7 / Transport and Installation of the Finished Top

During handling, transport and installation of the finished top, pay the utmost attention to avoid any excessive bending, twisting or knocks, particularly on the edges.

### 7.1 Packaging and transport

Once the slabs have been machined, handle the finished top vertically, keeping any openings towards the top. To facilitate transport, package the top in wooden crates or special wooden frames.

If the finished top is transported on trestles or stands, make sure that these are of the right size to completely protect the top.

The edges can also be protected with foam rubber or polystyrene corner guards.

### 7.2 Installation

Check that the base supporting the top is perfectly flat and level, structurally solid and stable.

Do this to ensure that the top can be continuously supported by the kitchen units over time. Check the flatness of the kitchen units scrupulously if the top has been made of more than one Laminam 12+ slab joined together, to ensure that the pieces fit perfectly.

Any cracks in the top caused by an uneven supporting surface or the subsequent settling of the units will not be considered a defect of the product.

On site, always handle the finished top vertically, keeping any openings towards the top.

To reduce the risk of breakage during assembly, handle the top until it is resting on the supporting surface by supporting the underside on a wooden panel.

Fix the top to the base using silicone, taking care to spread this uniformly.

If the top is made of more than one piece of Laminam 12+, pay particular attention during laying to prevent any impact on the visible edges. This operation can be facilitated with the use of shims that must be removed once the slabs are in position.

The coupled edges may be chamfered beforehand by the operator to make it easier to couple the pieces without chipping. Finally, fill the joint with silicone.



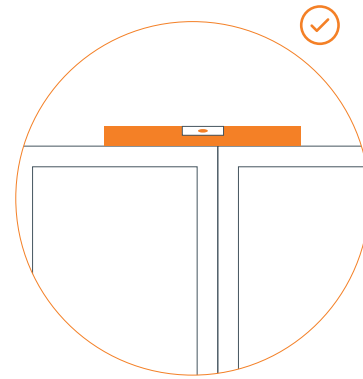
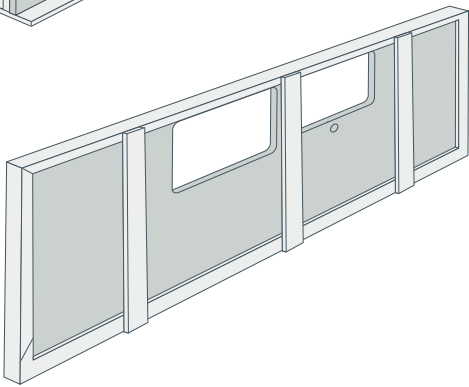
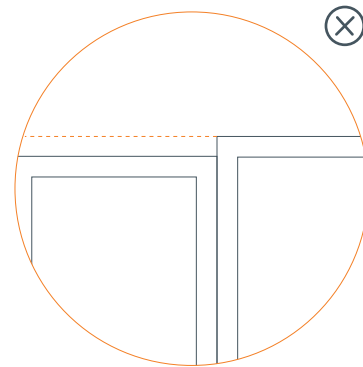
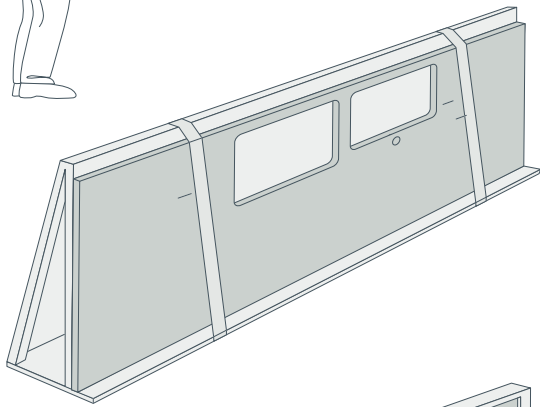
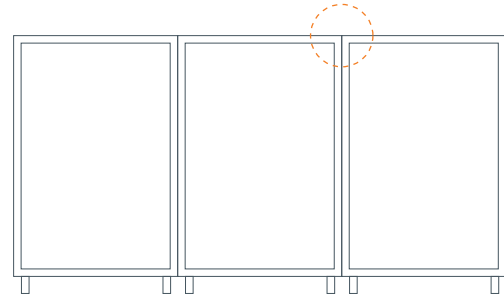
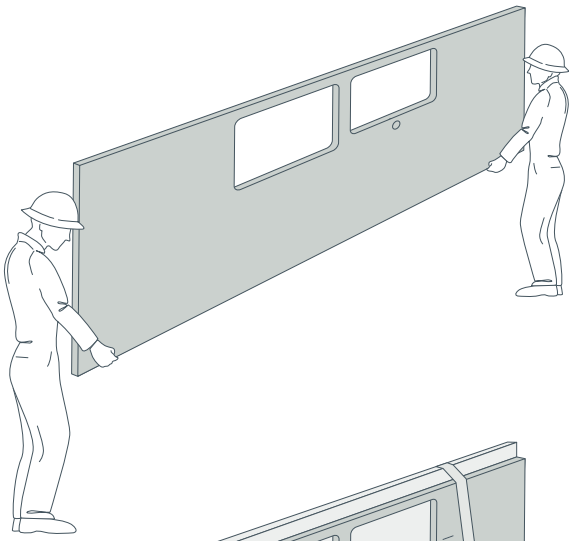

## 8 / Cleaning and Maintenance

### 8.1 Cleaning and maintenance Laminam 12+ Routine

Generally, for everyday cleaning of Laminam 12+ use hot water and neutral detergents if required, with a soft cloth. Follow the instructions given on the detergent package.

Rinse with plenty of water and dry the surface with a soft cloth.

To prevent matt stains, do not use products containing wax.

Stains not promptly removed may leave more or less visible traces on the surface, in accordance with the tolerance of the specific type of finishing.

#### Intense

To remove stains or particularly resistant residues from the Laminam 12+ surface, clean first with hot water and neutral detergent.

If this is not sufficient, use increasingly incisive cleaning techniques and specific products, depending on the stain, including:

- Non-abrasive neutral pH detergents
- Slightly abrasive detergents
- Acid or alkali detergents
- Solvent-based detergents

It is fundamental to comply with the information given in the technical data sheets and product labels.

#### For resistant stains or marks:

1. Liberally apply Ajax cream cleanser
2. Wet a Scotchbrite pad and dab on Ajax baking soda cream cleanser to create a frothy solution
3. With the flat of your hand use the green 3M™ Scotchbrite™ and foam™ All-Purpose Scrubber in a circular motion and clean the entire benchtop, avoid prolonged rubbing in one spot.
4. Wipe off the excess liquid and rinse with a clean damp cloth.
5. Leave to dry or dry off with a quality Micro-Fibre cloth.

Stubborn organic stains can be removed with an Organic Stain remover.

Staining agent	Type of detergent	Product
Olive oil	Clean with hot soapy water then rinse off with a clean cloth	Ajax Spray n Wipe
Coffee		OSR
Tea		OSR
Tomato		OSR
Red wine		OSR
Fruit Juice		OSR
Cosmetics		Acetone
Grease and oily substances	Neutral detergent, degreasing agent	Degreaser
Wax		C.L.R
Rust		Cerapol
Metallic marks		30 Seconds Water Spot Remover
Limescale residues	Acid-based detergent	30 Seconds Water Spot Remover
		C.L.R
		Bar Keepers Friend Tile cleaner
Ink	Acid-based detergent	Acetone
Marker pen		White Spirits
Nail varnish		I.P.A



## 8.2 Recommended Cleaning Products



Bar Keepers Friend Tile cleaner



Cerapol



Ajax Spray n Whipe



Acetone



IPA



30 Seconds Water Spot Remover



Ajax Spray n Wipe Glass



Ajax Cream Cleanser

## 8.2 Recommended Cleaning Products Cont.



Organic Stain Remover



Green Scotchbrite Pad

## 9 / Surface Restoring

If the surfaces become damaged or chipped during the use of the top, given the specific technical and mechanical characteristics of porcelain stoneware and ceramic materials generally it is not possible to make these defects completely disappear as can be done with other products.

While not advised, the slabs can be restored using epoxy 2-component glues in a similar colour to that of the Laminam 12+ slab, though with different properties and finishes from the original surface.

# 10 / Technical Specifications

## Furniture industry



physical and chemical properties /	norm / test method	Laminam 12+
density /	EN 14617-1 ASTM C97	2500 kg/m <sup>3</sup> (average value)
water absorption /	EN 14617-1	average value 0.1%
bending strength /	EN 14617-2	50 MPa (average value)
freeze and thaw resistance /	EN 14617-5	resistant
dry heat resistance /	EN 12722 EN 438-2 par.16	5 (no visible effect till 200°C)
chemical resistance /	ISO 10545-13	from class A to B
chemical resistance /	ASTM C650	resistant
cold liquid resistance /	EN 12720	5 no visible effect except ink (2)
cleaner product resistance /	PTP 53 CATAS	5 no visible effect
abrasion resistance /	EN 14617-4	28.0 mm
hygiene properties /	Metodo CATAS	excellent (high degree of removal of bacterial cells >99% after cleaning with a biocide-free detergent)
resistance to fungi /	ASTM G21	no fungal growth
lead and cadmium given off /	ISO 10545-15	0 mg/dm <sup>3</sup>
overall migration /	UNI EN 1186	0 mg/dm <sup>2</sup> / no significant migration
VOC emission /	UNI EN 16000-9	class A+ French
shock resistance /	ISO 4211-4 EN 14617-9	no damage 400mm / average value 3
light resistance /	UNI EN 15187	5 no visible effect
thermal shock resistance /	EN 14617-6	resistant
resistance to staining /	ASTM C1378	resistant

## Technical specifications

physical and chemical properties /	norm / test method	Laminam 12+
Full Size: "length and width" nominal size: size / 1620x3240mm	Laminam	minimum size: ≥ 1620x3240 mm full size untrimmed
"length and width" nominal size/manufacturing: 1620x3240mm size	ISO 10545-2	max. deviation on the side +/- 0.5 mm
full size: squareness: 1620x3240mm size	Laminam	not applicable full size untrimmed
rectified: squareness 1620x3240mm size	Laminam	max deviation on the diagonal +/- 1.5 mm
weight /	Laminam	average value 30 kg/m <sup>2</sup>
surface quality / % pof tiles with no visible flaws	ISO 10545-2	> 95%
water absorption /	ISO 10545-3 / ASTM C373	≤ 0.3%
breaking strength in N / camp. 200x300 mm	ISO 10545-4	average value 1100 (sample dimensions 200x300 mm)
modulus of rupture in N / mm <sup>2</sup>	ISO 10545-4	average value 50 (sample dimensions 200x300 mm)
Mohs scale hardness /	UNI EN 101	class: from 5 to 7
resistance to deep abrasion /	ISO 10545-6	≤ 175 mm <sup>3</sup>
coefficient of linear thermal expansion / 10 <sup>-6</sup> /°C	ISO 10545-8	6.6 average value
resistance to thermal shock /	ISO 10545-9	resistant
chemical resistance /	ISO 10545-13	class: from A to B
stain resistance /	ISO 10545-14	class: from 4 to 5
frost resistance /	ISO 10545-12	resistant
fire reaction /	EN 13501 (rev. 2005)	A2 - s1,d0



# 11 / Warranty

## 15 Year Limited 12mm Benchtop Warranty

Subject to the conditions and limitations set out in this warranty below, Laminex New Zealand™, a division of FLETCHER BUILDING PRODUCTS LTD, warrants to the original purchaser of Laminam® XL products for benchtop use (hereinafter referred to as “you” or “your”) that the product will meet the performance characteristics published below for a period of no less than 15 years from the date of original purchase.

This warranty applies to the full range of Laminam® XL products supplied by Laminex New Zealand™ (subject to any exceptions expressly excluded noted in Laminex New Zealand™ literature) and used in interior benchtop applications subject to the terms and conditions of this warranty.

### Terms and conditions

1. Laminex New Zealand™ warrants the following product performance characteristics (based on the criteria under the tests stated) of Laminam® for the term of the warranty:

- a) Colours and surfaces durability; even after prolonged exposure to light (Colour resistance to light DIN 51094: unaltered surface at completion of testing);
  - b) Waterproof surface (ISO 10545-3: water absorption average 0.1%);
  - c) Frost resistance (ISO 10545-12: no damaged slab after 100 cycles from -5°C to +5°C; ASTM C1026: no damage after 15 cycles);
  - d) Thermal shock resistance (ISO 10545-9: no slab damaged by 10 cycles from 145°C to 15°C, ASTM C484: no sample damaged);
  - e) Scratch resistance when it comes into contact with materials that are softer than ceramics; for example, a steel tip (UNI EN 101: Mohs scale value  $\geq 6$ );
  - f) Chemical resistance (ISO 10545-13: no visible consequence after immersion in the test solutions for 12 days; ASTM C650: no sample damaged);
  - g) Resistance to permanent stains (ISO 10545-14: Class 5, staining agents can be removed; ASTM C1378: no sample damage).
2. This warranty does not cover damage caused by:
- a) Any act of God, any natural occurrence or any other circumstance beyond Laminex New Zealand’s control; or
  - b) Application design or installation in any respect, or the failure to follow any procedures or guidance (if any) that may be issued in official product literature made available by Laminex New Zealand™, or best industry practices for the fabrication and installation of ceramic products (including, but not limited to, incorrect substrate preparation, or use of incorrect adhesives, or incorrect application of adhesives); or
  - c) Failure to follow the maintenance and cleaning guide for Laminam®, as set out in official product literature made available by Laminex New Zealand™; or
  - d) Physical abuse, misuse, accidents, impacts, incorrect handling, wear and tear, improper maintenance; or
  - e) Failure of any adhesive, grout, caulk, sealant or other accessory, or failure of any caulked or filled joint or seams; or
  - f) Events directly or indirectly attributable to the underlying substrate or structure, including building framing, building substructure or anchoring systems, or failure of any substrate or application design flaws, overloading of substrate, building movement, or any consequential or indirect loss or damage caused or contributed to by any defect; or
  - g) The product being used in applications not expressly recommended in official product literature made available by Laminex New Zealand™; or
  - h) Any Laminam® product that is not installed by an appropriately trained and skilled person; or
  - i) Variation in colour, pattern, shade of the material against the sample material, displays and/or printed illustrations (areas where colour matched slabs are desired, order as “batch matched” to minimise colour variation); or
  - j) Any exterior or cladding use or application (see separate Exterior Warranty), or other use other than as a Benchtop (see separate Interior Warranty); or
  - k) Where the defect is trivial or insubstantial; or
  - l) Where, as at the date of notification of the defect to Laminex New Zealand™, the type or colour of the alleged defective product no longer forms part of Laminex New Zealand’s standard stock range and the person complaining of the defect does not agree to the supply of a replacement which is as close a type or colour match as is possible from Laminex New Zealand’s then prevailing stock range; or

- m) Cracks or chips that appear after installation, cracks originating from sink or cooktop cuts and cutouts, cracks originating from "L" shape cuts and cutout, chips or cracking as a result of handling, cutting or polishing the slabs onsite or failure to follow recommended minimum edge profile details or mitred edge details where the join is not cut correctly; or
- n) Faults identifiable at the time of fabrication or installation which have not been cut around during fabrication, or issues arising from failure to batch match any sheets in the installation; or
- o) The appearance of the back surface of any sheets and issues arising from polishing the back of any sheets; or
- p) Use of mechanical fasteners directly onto sheets, scratches or damage to the surface after installation, mechanical damage caused by hitting or knocking sheets, chemical damage;
- q) Failure due to inadequate support or movement of the supporting structure;
- r) Failure due to improper fabrication and or installation (such as quality of joins, edge profiles), and the quality and appearance of all joins.
3. Subject to the terms of this warranty, this warranty applies only to Laminam® products supplied by Laminex New Zealand™:
- a) Which have not been moved from their original place of installation;
- b) Which have been used in an internal benchtop application;
- c) Which have been fabricated or installed by a business which has been directly supplied with such Laminam® products by Laminex New Zealand™;
- d) Which have been fabricated, installed, maintained, cleaned, used and protected in the manner set out in official product literature made available by Laminex New Zealand™ concerning those products, a copy of which may be obtained, free of charge, from the website laminex.co.nz or emailing Laminex New Zealand™ at the address given below; and
- e) Where Laminex New Zealand™ has been notified of the defect within seven days of the first person to become aware of it, or within seven days of such time as the defect ought reasonably to have been identified (whichever is earlier) and provided the product the subject of the notice is not removed or tampered with prior to Laminex New Zealand™ having the opportunity to inspect.
4. Subject to the terms of this warranty, Laminex New Zealand™ will, at its option, repair or replace the product free of charge. A replacement product from Laminex New Zealand™ may not be available in the same colour or shape as the original Laminam® product covered by this warranty. If a replacement product from Laminex New Zealand™ of the same colour or shape is not reasonably available, Laminex New Zealand™ reserves the right to provide a replacement product of as close a shape and colour match as is reasonably possible from Laminex New Zealand's then prevailing stock range in satisfaction of its obligations under this warranty.
5. This warranty does not cover costs or losses relating to:
- a) Removal of products or system
- b) Installation of new substitute products or system
- c) Damage to other products or surfaces if not installed correctly e.g. tiles or products used for splashbacks placed directly on the Laminam® surface.
- d) Restoration work
- e) Any other direct or indirect, or consequential costs, losses, expenses or loss of earnings.
6. Other than as provided in these terms, Laminex New Zealand™ will have no liability to a claimant (whether in statute, contract, tort, or otherwise at law or in equity) in respect of any defects in the product or for any loss, damage, costs or expenses caused by the product or defects in the product, provided that nothing in this paragraph 6 or otherwise in these terms excludes or modifies any legal rights you may have. This warranty should therefore not be read as exhaustive statement of the rights of the original end user or any other person.
7. If you are a consumer as defined under the Consumer Guarantees Act the Laminam® from Laminex New Zealand™ Products come with guarantees that cannot be excluded under the Consumer Guarantee Act.
8. This warranty is not transferable or assignable.
9. Any inquiries regarding this warranty or claims must be emailed to:
- Laminam® Warranties Laminex New Zealand™  
info@laminex.co.nz  
0800 303 606
- Laminam® is marketed and distributed by Fletcher Building Products Limited trading as Laminex New Zealand™.
- Laminex New Zealand™ is a trademark used under licence by Fletcher Building Products Limited trading as Laminex New Zealand™.

*Visit us*

**laminex.co.nz**

*Call us*

**0800 303 606**

*Samples*

**laminex.co.nz**

**or 0800 999 939**

*Follow Us*



**@laminexnz**



**@nzlaminex**

Laminam® is marketed and distributed by Laminex New Zealand™, a division of Fletcher Building Products Limited. The colours of the photographs and swatches depicted in this brochure are as close to the Laminam® range as modern photographic, lighting and printing processes allow. We always recommend making final colour selections from an actual sample. The colours shown are available at the time of publication, but are subject to availability and may be withdrawn at any time. © Copyright Reserved 2021 Laminam® is marketed and distributed by Laminex New Zealand™, a division of FLETCHER BUILDING PRODUCTS LTD.

Distributed and marketed by

**LAMINAM**  
SUPERIOR NATURAL SURFACES

**Laminex**™  
NEW ZEALAND